

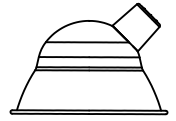

SPS-0544 REV B

**EMBLEM INTEGRATED LED SIGN LIGHT**

JOB NAME: \_\_\_\_\_ FIXTURE TYPE: \_\_\_\_\_



BLE - G - \_\_\_\_\_ - \_\_\_\_\_ - \_\_\_\_\_ - \_\_\_\_\_ - \_\_\_\_\_ - \_\_\_\_\_ - \_\_\_\_\_ - \_\_\_\_\_

A                      B                      C                      D                      E                      F                      G

\_\_\_\_\_ - \_\_\_\_\_ - \_\_\_\_\_ - \_\_\_\_\_

H                      I                      J                      K

Order Example: BLE - G - ASE14 - 100 - G10 - 980 - SWK - WC - 975 - NA - LED16 - 2700K - DL

**A - SHADE SIZE****REGALIA EMBLEM:**

- ASE10** 10" Shade  
**ASE12** 12" Shade  
**ASE14** 14" Shade

**B - SHADE FINISH****PORCELAIN FINISHES<sup>1</sup>:**

- 150** Black  
**250** White  
**350** Vintage Green  
**355** Jadite  
**455** Cherry Red  
**550** Yellow  
**650** Bronze  
**750** Cobalt Blue  
**765** Delphite Blue  
**850** Graphite  
**950** Metallic Chrome

**POWDER COAT FINISHES<sup>2</sup>:**

- 100** Black  
**105** Textured Black  
**200** White  
**300** Dark Green  
**307** Emerald Green  
**311** Jadite  
**370** Mint  
**380** Chartreuse  
**390** Teal  
**400** Barn Red  
**420** Orange  
**470** Watermelon  
**480** Blush Pink  
**490** Magenta  
**495** Sherbet Orange  
**500** Buttery Yellow  
**570** Sunflower  
**600** Bronze  
**601** Chocolate  
**605** Rust  
**615** Oil-Rubbed Bronze  
**700** Royal Blue  
**705** Navy  
**710** Cobalt Blue  
**715** Delphite Blue  
**790** Lavender  
**800** Industrial Grey  
**805** Charcoal Granite  
**810** Graphite  
**975** Galvanized

**B - SHADE FINISH (CONTINUED)****NATURAL METALS<sup>3</sup>:**

- 995** Raw Copper  
**996** Weathered Copper  
**997** Raw Brass  
**998** Weathered Brass  
**999** Oil-Rubbed Copper

**C - GOOSENECK ARMS****GOOSENECK OPTIONS:**

- |                        |                        |
|------------------------|------------------------|
| <b>G1<sup>4</sup></b>  | <b>G16<sup>4</sup></b> |
| <b>G2<sup>4</sup></b>  | <b>G17</b>             |
| <b>G5<sup>4</sup></b>  | <b>G22</b>             |
| <b>G6</b>              | <b>G24</b>             |
| <b>G7</b>              | <b>G25</b>             |
| <b>G8</b>              | <b>G26<sup>4</sup></b> |
| <b>G9</b>              | <b>G32</b>             |
| <b>G10</b>             | <b>G34<sup>4</sup></b> |
| <b>G11<sup>4</sup></b> | <b>G35<sup>4</sup></b> |
| <b>G12<sup>4</sup></b> | <b>G36<sup>4</sup></b> |
| <b>G13</b>             | <b>G64<sup>4</sup></b> |
| <b>G14</b>             | <b>G65<sup>4</sup></b> |
| <b>G15</b>             |                        |

**D - GOOSENECK ARM FINISH**

*Please Note: See **Section B** for all applicable Gooseneck Arm Finish Options. Gooseneck arms are also available in 980-Brushed Aluminum. (1) If a Porcelain shade finish is selected, gooseneck arm will be powder coat painted-to-match. Porcelain shade finishes are not available with a Natural Metal mounting finish*

- 980** Brushed Aluminum<sup>5</sup>

**E - SWIVEL KNUCKLE**

- NA** None/Not Applicable  
**SWK** Swivel Knuckle<sup>4</sup>

**F - SHADE ACCESSORIES**

- NA** None  
**WC** Wire Cage<sup>4</sup>

**G - SHADE ACCESSORY FINISH**

*Please Note: See **Section B** for all applicable Accessory Finish Options. (I) Wire Cage not available in Natural Metals. (II) If Porcelain Finish is selected, accessory will be powder coat painted-to-match. (III) If no accessory selected in Section F, select NA.*

- NA** Not Applicable

**H - MOUNTING ACCESSORY**

*Please Note: Mounting Accessories below are only applicable with select Mounting Styles. Please refer to product listings on our website for further detail.*

- NA** None/Not Applicable  
**DD** Dusk-to-Dawn Photocell  
**LDBPC** LED Decorative Backing Plate Cover  
**LDCHX** LED Decorative Backing Plate Cover & Hex Cover

**I - LIGHT SOURCE**

- LED11** 850 Lumen, 11W LED  
**LED16** 1250 Lumen, 16W LED  
**LED27** 2000 Lumen, 27W LED

**J - COLOR TEMPERATURE**

- 2700K** 2700K, Warm White  
**3000K** 3000K, Neutral White  
**3500K** 3500K, Bright White  
**4000K** 4000K, Cool White

**K - LED LENS**

- DL** Domed lens

**IMPORTANT:** (1) All Porcelain Enamel finished shades feature a white interior and a black outer rim (2) All Powder Coat finished shades, Galvanized excluded, feature a white interior (3) Natural Metals have a longer estimated manufacturing time, please check the website for exact lead time. There are no returns accepted on Natural Metals (4) Not available in Natural Metals (5) Not available with the G36, G40, G64, and G65

**MOUNTING STYLE**

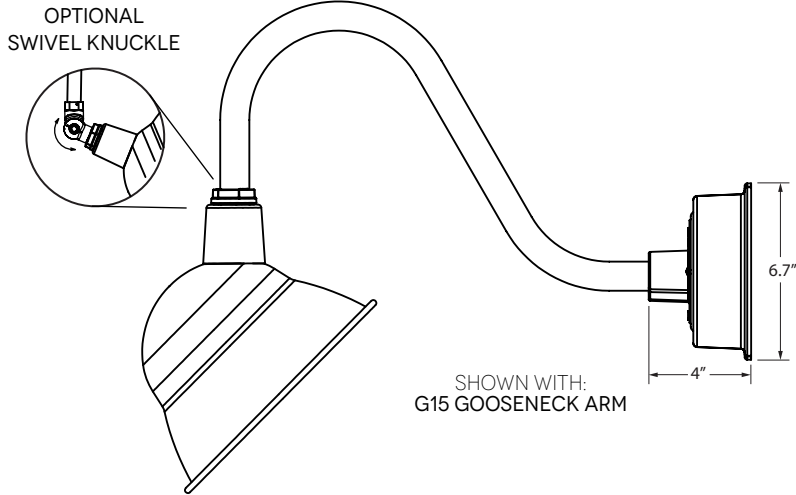

**LUMINAIRE DIMENSIONS**

SHADE CODE	HEIGHT (A)	DIAMETER (B)
ASE10	7"	10"
ASE12	8.5"	12"
ASE14	9.5"	14"

**LIGHT SOURCE**

All published luminaire photometric testing performed to IESNA LM-79-08 standards by a NVLAP accredited laboratory. Data is considered to be representative of the configurations shown, within the tolerances allowed by Lighting Facts. To obtain an IES file specific to your project, please contact the factory.

		850		1250		2000	
		440		440		900	
		11		16		27	
Shade Size	Optics	Delivered Lumens	LPW	Delivered Lumens	LPW	Delivered Lumens	LPW
ASE10	Domed	719	63	1058	66	1693	63
ASE12	Domed	720	63	1059	66	1695	63
ASE14	Domed	721	63	1060	66	1697	63

**SPECIFICATIONS**

**CERTIFICATIONS, LISTINGS & WARRANTY**

MADE IN THE USA  
 Manufactured and Hand-Crafted in Our 60,000 Square Foot Facility  
 Located in Titusville, FL

CSA LISTED FOR WET LOCATIONS

OPERATING TEMPERATURE RANGE  
 -30°C to 40°C

LIMITED WARRANTY  
 For Additional Information on Our Limited Warranty, Please See  
 Our Terms & Conditions

**CONSTRUCTION & FINISH**

POWDER COAT SHADE  
 Hand-Spun from High Purity 3003-O Temper Aluminum

GALVANIZE SHADE  
 Hand Spun from High Quality Galvanized Steel

PORCELAIN SHADE  
 Hand-Spun from 20 Gauge Porcelain Steel

POWDER COAT FINISHES  
 Polyester Powder Coat Finishes Are Electro-Statically Applied and  
 Thermocured

PORCELAIN FINISHES  
 Applied by Hand and Fired in a High Temperature Oven

**SPECIFICATIONS (CONTINUED)**

**CONSTRUCTION & FINISH (CONTINUED)**

COPPER  
Hand-Spun from High Purity .032 Thick C11000-O60 ETP Copper

BRASS  
Hand-Spun from High Purity .050" Thick C2600-O60 Brass

GOOSENECK  
1/2" Nominal (0.84" Actual) or 3/4" Nominal (1.05" Actual) Sch 40, 6063 Aluminum Gooseneck

MAX FIXTURE WEIGHT  
10 lbs

**LED LIGHT SOURCE**

LED TYPE: CREE LMH2 MODULE

INITIAL LUMENS DELIVERED: UP TO 2000 LUMENS

L90(6K) > 36,300 HOURS

AVAILABLE CCT: 2700K, 3000K, 3500K, 4000K  
Custom Temperatures Available upon Request

90+ CRI

2 STEP MACADAMS ELLIPSE

EFFICACY: UP TO 66 LPW. SEE LUMEN CHART  
High Efficacy Available upon Request, Consult Factory for Additional Information

**ELECTRICAL/LED DRIVER**

POWER FACTOR > 0.9

EFFICIENCY: UP TO 87% TYPICAL

INPUT VOLTAGE: 120-277 VAC (SEE DIMMING SECTION)

CLASS 2 POWER SUPPLY

LED DRIVER LIFETIME: > 100,000 HOURS (@ 25 DEG C AMBIENT)

IP64 MINIMUM RATING CASE WITH SILICONE-BASED POTTING

PROTECTIONS

Output Open Load, Over-Current and Short-Circuit (Hiccup), and Over-Temperature with Auto Recovery

CONDUCTED AND RADIATED EMI

Compliant with FCC CFR Title 47 Part 15 Class B (120 VAC), Class A (277 VAC) and EN55015 (CISPR 15) at 220, 230 and 240 VAC

COMPLIANT WITH

Complies with Energy Star® DLR (DesignLight Consortium®) and CA Title 24 Technical Requirements

**DIMMING**

TRI-MODE DIMMING™

Compatible with TRIAC (Forward-Phase or Leading-Edge), ELV (Reverse-Phase or Trailing-Edge) and 0-10 V Dimmers

TRIAC AND ELV DIMMING ONLY AT 120 VAC

DIMMING RANGE 1-100%

The Dimming Range is Dependent on Each Specific Dimmer. May not be able to Achieve 1% Dimming with Some Dimmers

ELV DIMMING AT 230 VAC  
Available by Request



# LED GOOSENECK LIGHTING

MKT-0019, REV A

With their iconic style and practical purpose, our selection of LED compatible gooseneck arms contains the ideal option for every space. To properly illuminate interior and exterior settings, a variety of angles and shapes focus light onto sidewalks, tables and more. Every gooseneck arm is constructed in our Florida-based manufacturing facility. Please Note: Select gooseneck arms cannot be used with certain designs and shades. For additional information, please visit the individual product listing. Additionally, gooseneck arms indicated with an asterisk are not available in copper and brass finishes.

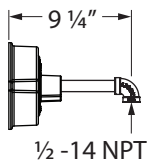

**G3\***

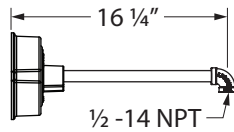

**G1\***

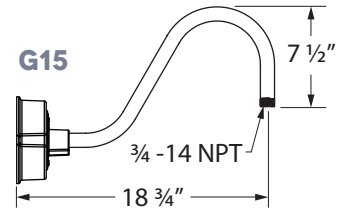

**G15**

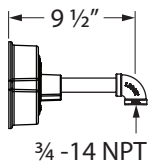

**G4**

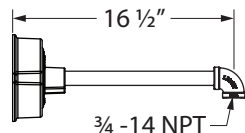

**G14**

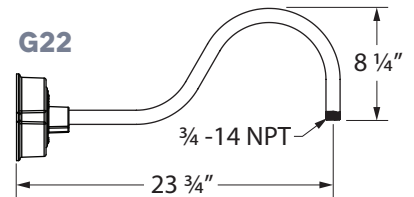

**G22**

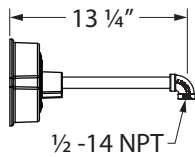

**G16\***

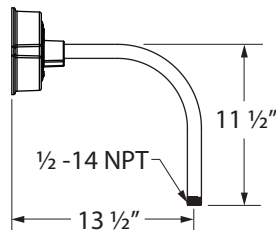

**G12\***

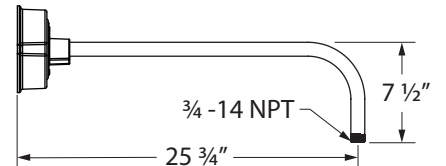

**G8**

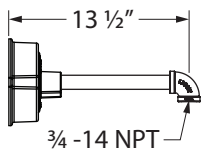

**G17**

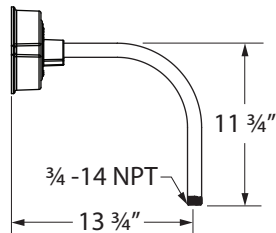

**G13**

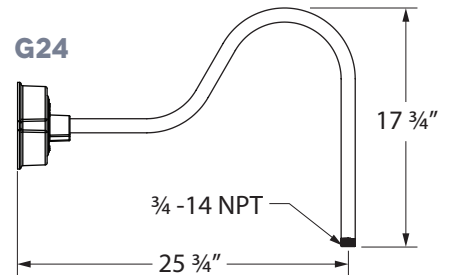

**G24**

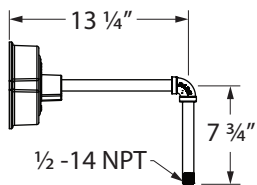

**G35\***

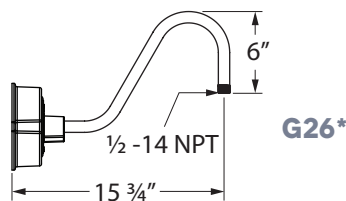

**G26\***

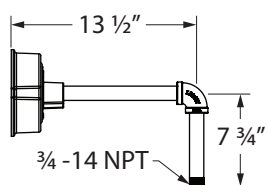

**G34\***

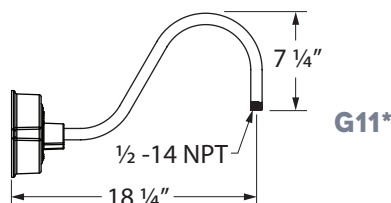

**G11\***

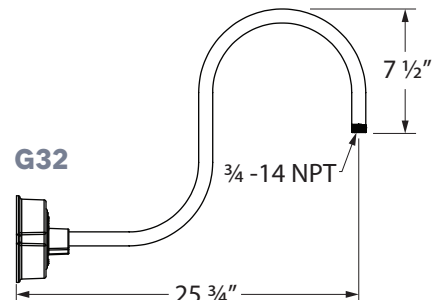

**G32**

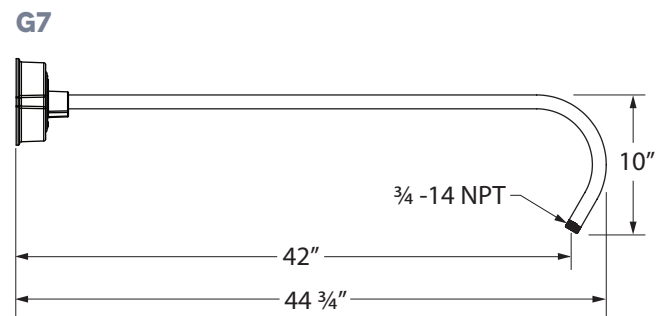
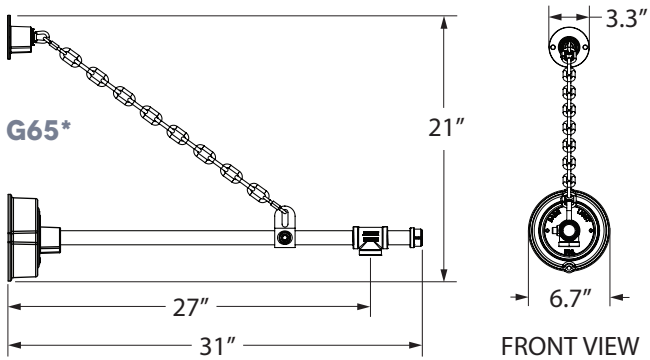
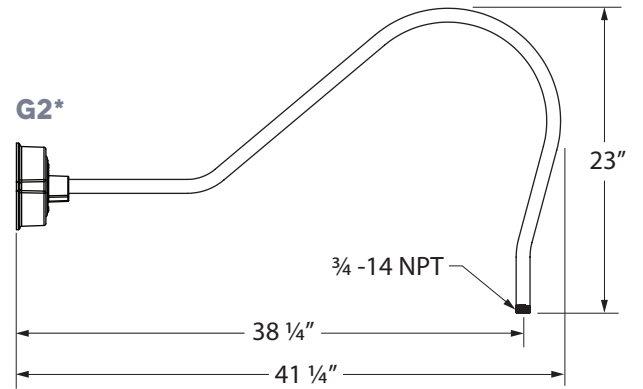
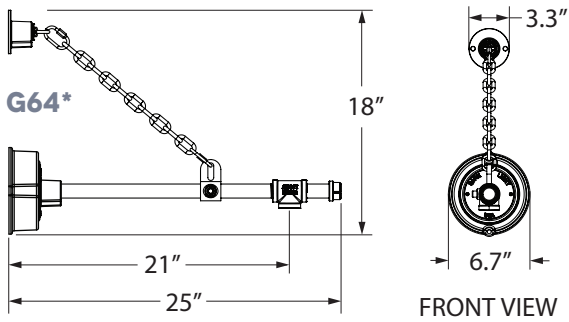
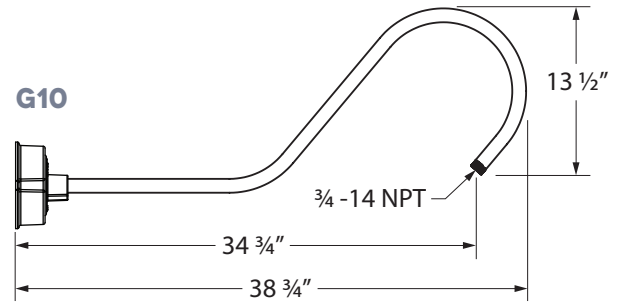
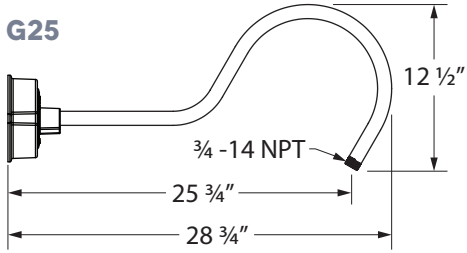
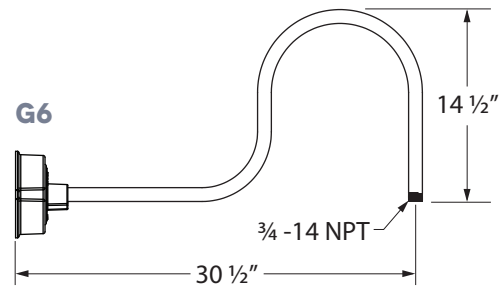
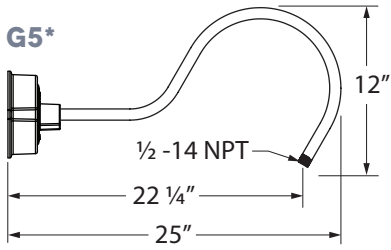

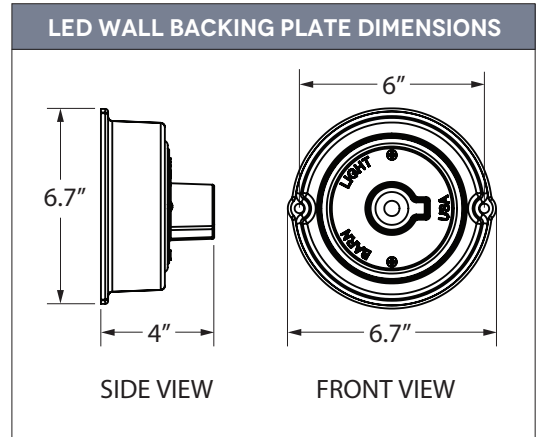
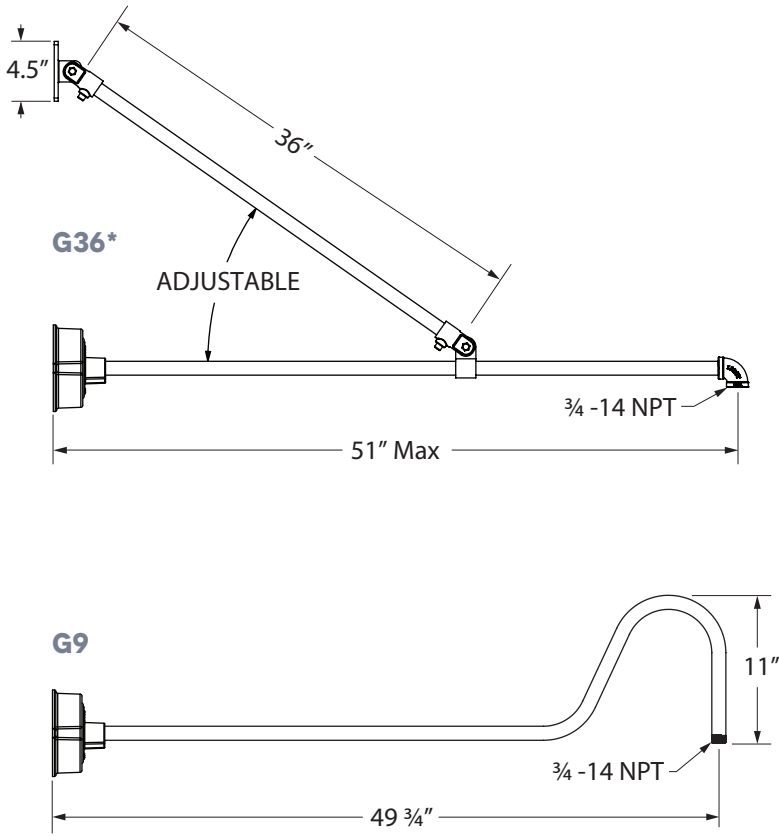

**OPTIONAL MOUNTING ACCESSORIES**

For a more formal and refined aesthetic, a decorative cover can conceal the gooseneck's backing plate. With an array of powder coat colors, the backing plate takes on various looks, ranging from playful to simple and timeless, while natural copper and brass finishes offer a more sophisticated style.

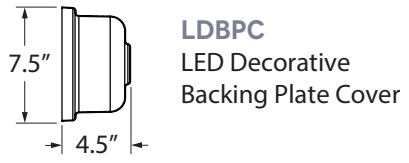



Different accessories completely alter the look and feel of a light. By selecting a durable cast guard and glass or a rugged wire cage, our lights take on a trendy industrial character. Not only are these accessories stylish, but they also protect the bulb in commercial or industrial settings!

## GUARD OPTIONS

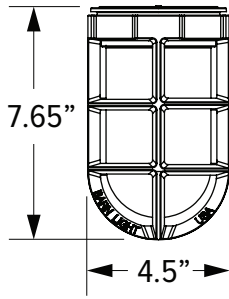

TGG Heavy Duty Cast Guard

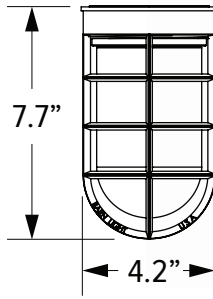

CGG Standard Cast Guard

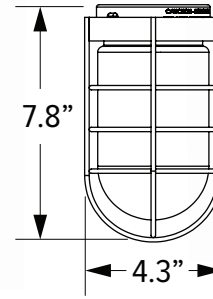

WGG Wire Guard



## GLASS OPTIONS

Not Applicable with Halogen Lights



CLR  
Clear



FST  
Frosted



RIB  
Ribbed

## WIRE CAGE

Not Applicable with Guard and Glass or Select Shade Styles

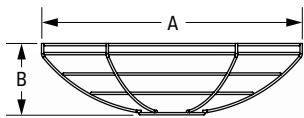

WC Wire Cage

DIAMETER (A)	HEIGHT (B)
8"	2.7"
10"	2.9"
11"	3.2"
12"	3.4"
13"	3.7"
14"	3.9"
15"	4.2"
16"	4.4"
17"	4.7"
18"	4.9"
20"	5"

## ACRYLIC DIFFUSER

Not Applicable with Guard and Glass, GU24 Sockets, or Select Shade Styles



Shade Not Included

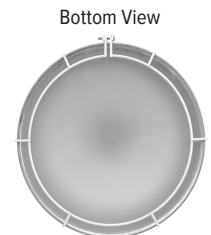

ACR Acrylic Diffuser

\*Please contact Barn Light Electric with any questions regarding applicable shade sizes and light sources.