

DESCRIPTION

The Encounter™ redefines ambient lighting by being the first fixture to blend modern contemporary styling with the innovative WaveStream™ technology to deliver exceptional performance and superior energy savings. Encounter's highly efficient LED system with advance optical design delivers an unparalleled combination of optimal light uniformity for enhanced visual comfort and superior efficiency for greater energy savings.

Encounter is compatible with all of today's popular ceiling systems and available in a variety of configurations for application versatility. Its perfect balance of form and function make it an ideal choice for commercial office spaces, schools, hospitals, retail and other indoor ambient applications.

SPECIFICATION FEATURES

Construction

Shallow 3-1/4" deep housing is extruded aluminum frame and injected molded composite end plates. End plates are securely attached with screws for strength and rigidity and the elimination of gaps. End plates have accessory grid-lock feature for safety and convenience. Four auxiliary fixture end suspension points are provided. Large access plate for supply connection.

Controls

The Encounter LED is Powered by Fifth Light, with a standard 0-10V continuous dimming driver that works with any 0-10V control/dimmer. Combine with energy saving products like occupancy sensors, daylighting controls and lighting relay panels to maximize energy savings. In addition, the Encounter can include a factory-installed integrated sensor system for occupancy and daylight dimming control and manual control from an optional handheld remote. Or, specify the Digital Addressable Lighting Interface (DALI) drivers, dimmable down to

1% with the HD option, for use with Fifth Light controls. See ordering information for details on all three options.

Electrical

Long-life LED system coupled with electrical driver to deliver optimal performance. LED's available in 3000K, 3500K, 4000K or 5000K with a typical CRI ≤ 85. Projected life is 100,000 hours at 92% lumen output. Electronic drivers are available for 120-277V applications.

Emergency Battery Pack Option

Optional 120v-277v integral emergency battery pack is available in 7-watts or 14-watts to meet critical life-safety lighting requirements. The 90-minute batteries provide constant power to the LED system, ensuring code-compliance. A test switch/indicator button can be tested safely from the ground using a laser pointer, while the patented EZ Key prevents accidental discharge of the battery during construction. See ordering information for details.

Driver Access

Drivers can be accessed via plenum.

Finish

Durable frame has high reflectance baked matte white enamel finish for luminous uniformity.

Optics

Precision formed optical assembly with positively retained high optical grade acrylic lenses provide a directed optical distribution using WaveStream technology.

Compliance

Components are UL recognized. Indoor luminaires are cULus and CSA listed for 25° C ambient environments, RoHS compliant, and comply with IESNA LM-79. LEDs comply with LM-80 standards. DesignLights Consortium™ Qualified and classified for DLC Standard, refer to www.designlights.org for details.

Warranty

Five year warranty.



**24EN
LED**

**2' X 4' TROFFER
LED MODULE**

Specification Grade Troffer



powered by
fifthlight
technology

CERTIFICATION DATA

cULus - 1598 and 2043**
Damp Location Listed
CSA
IC Rated
LM79/LM80 Compliant
ROHS Compliant
DesignLights Consortium™ Qualified
NOM Compliant

*See Drywall Frame Kit Accessory in Ordering Information section.

**Fixture construction is suitable for use in Air-handling and plenum rated spaces in accordance with Section 300.22 (C) of the National Electrical Code, Section 4.3.11.2.6.5 of NFPA 90A and Section 602.2.1.4 of ICC.

LINEAR DISCONNECT

Safe and convenient means of disconnecting power



PS519063EN
2016-03-07 13:51:40

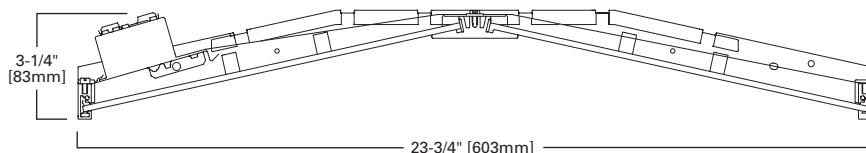

MOUNTING DATA

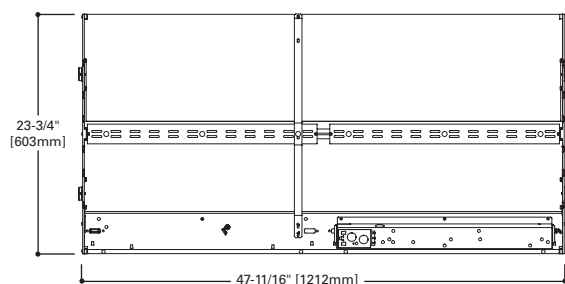

LAMP CONFIGURATIONS

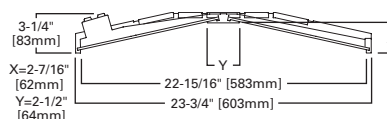

CEILING COMPATIBILITY

G
Grid/Lay-in
Standard

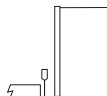

F
Drywall Frame
Kit



**Ceiling
Type**

Exposed Grid
Concealed T
Slot Grid
Flange

**Trim
Type**

G
G or T
G or T
*

PHOTOMETRICS

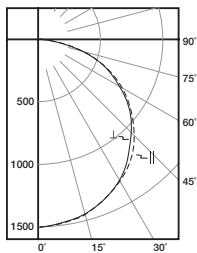

24EN-LD2-45-UNV-L835-CD1-U

Electronic Driver
 Linear LED 3500K
 Spacing criterion:
 (||) 1.3 x mounting
 height, (⊥) 1.3 x
 mounting height
 Lumens: 4520
 Input Watts: 38.0W
 Efficacy: 118.9 lm/W
 Test Report:
 24EN-LD2-45-UNV-
 L835-CD1-U.IES

Candlepower

Angle	Along	45°	Across ⊥
0	1493	1493	1493
5	1493	1485	1487
10	1475	1466	1468
15	1445	1435	1437
20	1403	1392	1395
25	1352	1340	1342
30	1292	1278	1277
35	1222	1204	1200
40	1144	1123	1120
45	1060	1034	1033
50	964	939	939
55	860	833	836
60	748	719	724
65	624	591	606
70	492	467	460
75	357	337	284
80	218	187	192
85	93	90	87
90	0	0	0

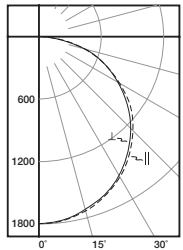

24EN-LD2-54-UNV-L835-CD1-U

Electronic Driver
 Linear LED 3500K
 Spacing criterion:
 (||) 1.3 x mounting
 height, (⊥) 1.3 x
 mounting height
 Lumens: 5410
 Input Watts: 43.0W
 Efficacy: 125.8 lm/W
 Test Report:
 24EN-LD2-54-UNV-
 L835-CD1-U.IES

Candlepower

Angle	Along	45°	Across ⊥
0	1791	1791	1791
5	1792	1782	1784
10	1770	1759	1761
15	1734	1721	1723
20	1684	1670	1673
25	1621	1609	1610
30	1550	1533	1531
35	1465	1444	1439
40	1372	1348	1344
45	1270	1241	1238
50	1153	1124	1125
55	1029	997	998
60	893	860	867
65	743	706	721
70	588	558	550
75	423	401	345
80	258	223	226
85	110	106	101
90	0	0	0

Coefficients of Utilization

rc rw RCR	Effective floor cavity reflectance																							
	80%				70%				50%				30%				10%				0%			
	70	50	30	10	70	50	30	10	50	30	10	50	30	10	50	30	10	50	30	10	50	30	10	0
0	119	119	119	119	116	116	116	116	111	111	111	106	106	106	102	102	102	100						
1	108	103	99	95	106	101	97	93	97	93	90	93	90	88	89	87	85	83						
2	98	90	83	77	95	88	81	76	84	79	74	81	76	72	78	74	71	68						
3	89	78	70	63	87	77	69	63	74	67	62	71	65	60	68	64	59	57						
4	82	69	60	53	79	68	59	53	65	58	52	63	57	51	61	55	51	48						
5	75	62	52	46	73	61	52	45	58	51	45	56	50	44	54	49	44	42						
6	69	55	46	40	67	54	46	39	53	45	39	51	44	39	49	43	38	36						
7	64	50	41	35	62	49	41	35	48	40	34	46	39	34	45	39	34	32						
8	59	46	37	31	58	45	37	31	44	36	31	42	36	31	41	35	30	28						
9	56	42	34	28	54	41	33	28	40	33	28	39	32	27	38	32	27	25						
10	52	39	31	25	51	38	30	25	37	30	25	36	30	25	35	29	25	23						

Zonal Lumen Summary

Zone	Lumens	% Fixture
0-30	1166	25.8
0-40	1922	42.5
0-60	3475	76.9
0-90	4520	100.0
0-180	4520	100.0

Coefficients of Utilization

rc rw RCR	Effective floor cavity reflectance																																															
	80%								70%								50%								30%								10%								0%							
	70	50	30	10	70	50	30	10	50	30	10	50	30	10	50	30	10	50	30	10	50	30	10	50	30	10	50	30	10	50	30	10	0															
0	119	119	119	119	116	116	116	116	111	111	111	106	106	106	102	102	102	100																														
1	108	103	99	95	106	101	97	93	97	93	90	93	90	88	89	87	85	83																														
2	98	90	83	77	95	88	81	76	84	79	74	81	76	72	78	74	71	68																														
3	89	78	70	63	87	77	69	63	74	67	62	71	65	60	68	64	59	57																														
4	82	69	60	53	79	68	59	53	65	58	52	63	57	51	61	55	51	48																														
5	75	62	52	46	73	61	52	45	58	51	45	56	50	44	54	49	44	42																														
6	69	55	46	40	67	54	46	39	53	45	39	51	44	39	49	43	38	36																														
7	64	50	41	35	62	49	41	35	48	40	34	46	39	34	45	39	34	32																														
8	59	46	37	31	58	45	37	31	44	36	31	42	36	31	41	35	30	28																														
9	56	42	34	28	54	41	33	28	40	33	28	39	32	27	38	32	27	25																														
10	52	39	31	25	51	38	30	25	37	30	25	36	30	25	35	29	25	23																														

Zonal Lumen Summary

Zone	Lumens	% Fixture
0-30	1398	25.8
0-40	2305	42.6
0-60	4164	77.0
0-90	5410	100.0
0-180	5410	100.0

LUMEN MAINTENANCE

Ambient Temperature	TM-21 Lumen Maintenance (100,000 hours)	Theoretical L70 (Hours)
25°C	> 92%	> 448,000

Non-IC data

ENERGY AND PERFORMANCE DATA BY CATALOG NUMBER

Stock or MTO*	Catalog Logic (Curved)	Delivered Lumens	Watts	Efficacy (LPW)
MTO	24EN-LD2-30-UNV-L830-CD1-U	2935	24.6	119
MTO	24EN-LD2-30-UNV-L835-CD1-U	3026	24.6	123
MTO	24EN-LD2-30-UNV-L840-CD1-U	3087	24.6	125
MTO	24EN-LD2-30-UNV-L850-CD1-U	3359	24.6	137
MTO	24EN-LD2-34-UNV-L830-CD1-U	3400	28.7	118
MTO	24EN-LD2-34-UNV-L835-CD1-U	3505	28.7	122
MTO	24EN-LD2-34-UNV-L840-CD1-U	3575	28.7	125
MTO	24EN-LD2-34-UNV-L850-CD1-U	3891	28.7	136
MTO	24EN-LD2-40-UNV-L830-CD1-U	3960	33.9	117
MTO	24EN-LD2-40-UNV-L835-CD1-U	4082	33.9	120
MTO	24EN-LD2-40-UNV-L840-CD1-U	4164	33.9	123
MTO	24EN-LD2-40-UNV-L850-CD1-U	4531	33.9	134
MTO	24EN-LD2-45-UNV-L830-CD1-U	4384	38.0	115
STOCK	24EN-LD2-45-UNV-L835-CD1-U	4520	38.0	119
STOCK	24EN-LD2-45-UNV-L840-CD1-U	4610	38.0	121
MTO	24EN-LD2-45-UNV-L850-CD1-U	5017	38.0	132
MTO	24EN-LD2-49-UNV-L830-CD1-U	4802	42.2	114
MTO	24EN-LD2-49-UNV-L835-CD1-U	4950	42.2	117
MTO	24EN-LD2-49-UNV-L840-CD1-U	5049	42.2	120
MTO	24EN-LD2-49-UNV-L850-CD1-U	5494	42.2	130
MTO	24EN-LD2-54-UNV-L830-CD1-U	5248	43.0	122
STOCK	24EN-LD2-54-UNV-L835-CD1-U	5410	43.0	126
STOCK	24EN-LD2-54-UNV-L840-CD1-U	5518	43.0	128
MTO	24EN-LD2-54-UNV-L850-CD1-U	6005	43.0	140
MTO	24EN-LD2-58-UNV-L830-CD1-U	5663	47.0	120
MTO	24EN-LD2-58-UNV-L835-CD1-U	5838	47.0	124
MTO	24EN-LD2-58-UNV-L840-CD1-U	5955	47.0	127
MTO	24EN-LD2-58-UNV-L850-CD1-U	6480	47.0	138
MTO	24EN-LD2-67-UNV-L830-CD1-U	6529	56.1	116
STOCK	24EN-LD2-67-UNV-L835-CD1-U	6731	56.1	120
STOCK	24EN-LD2-67-UNV-L840-CD1-U	6866	56.1	122
MTO	24EN-LD2-67-UNV-L850-CD1-U	7471	56.1	133
MTO	24EN-LD2-70-UNV-L830-CD1-U	6812	60.2	113
MTO	24EN-LD2-70-UNV-L835-CD1-U	7023	60.2	117
MTO	24EN-LD2-70-UNV-L840-CD1-U	7163	60.2	119
MTO	24EN-LD2-70-UNV-L850-CD1-U	7796	60.2	130
MTO	24EN-LD2-74-UNV-L830-CD1-U	7259	63.6	114
MTO	24EN-LD2-74-UNV-L835-CD1-U	7484	63.6	118
MTO	24EN-LD2-74-UNV-L840-CD1-U	7634	63.6	120
MTO	24EN-LD2-74-UNV-L850-CD1-U	8307	63.6	131

*Made to order (MTO) requires a typical two week lead time.

ORDERING INFORMATION

SAMPLE NUMBER: 24EN-LD2-67-UNV-L835-CD1-SVPD1-U

Rating Blank=Standard ATW-SW4=Chicago Rated ⁽⁷⁾	Lamp Type LD2=LED 2.0	Optics Blank=Standard	Driver Type CD=0-10V Dimming Driver (10% - 100% Dimming) HCD=0-10V Dimming Driver (1% - 100% Dimming) ⁽¹³⁾ SD=Step-dim Driver ^{(4),(15)} 5LTD=Fifth Light DALI Driver (10% - 100% Dimming) ^{(2),(15)} 5LTHD=Fifth Light DALI Driver (1% - 100% Dimming) ^{(2),(8)}	Number of Drivers 1=1 Driver 2=2 Drivers ⁽¹³⁾
Series ⁽⁶⁾ 24EN=2' x 4' Encounter Series	Stock Lumen Outputs 45=4500 Lumens 54=5400 Lumens 67=6700 Lumens MTO Lumen Outputs ^{(4),(15)} 30=3000 Lumens 34=3400 Lumens 40=4000 Lumens 49=4900 Lumens 58=5800 Lumens 70=7000 Lumens 74=7400 Lumens	Voltage ⁽¹⁾ 347V=347 Volt ^{(5),(9)} UNV=Universal Voltage 120-277 Options Emergency EL7W=7-watt, 120V-277V emergency battery pack installed ⁽³⁾ EL14W=14-watt 120V-277V emergency battery pack installed ⁽³⁾ GTD2=Bodine Generator Transfer Device ⁽¹⁴⁾ ETS2=IOTA Emergency Transfer Switch ⁽¹⁴⁾ CCT L830=3000K L835=3500K L840=4000K L850=5000K Flex ⁽¹²⁾ Multiple Configurations Available		
Air [Blank]=Standard A=Air (Vented) ⁽¹⁰⁾				

Product Family S=Integrated Sensor	Occupancy Technology P=Passive Infrared	Sensing Technology D=Dimming Daylight Harvesting (Closed Loop)	Coverage Pattern 1= ~144 Square Feet	Packaging U=Unit Pack PALC=Job Pack, in carton
Control Type B=Sensor Mounting, No Sensor V=Analog (0-10V) Output for Local Control ⁽¹¹⁾				

NOTES: ⁽¹⁾Products also available in non-US voltages and frequencies for international markets. ⁽²⁾Must be used in conjunction with a DALI control system. For complete DALI solutions by Fifth Light, visit www.eaton.com/lightingsystems ⁽³⁾With integral test switch/indicator/laser test. For approximate delivered lumens multiply the lumens per watt of the desired fixture by the wattage of the emergency battery pack (100 lm/W x 7=700 lumens). IES-format photometry for luminaire under emergency operation available. ⁽⁴⁾Step-dim driver not available with 3000, 3400, 7000 and 7400 lumen options. ⁽⁵⁾347V emergency option not available. ⁽⁶⁾DesignLights Consortium™ Qualified and classified for DLC Standard (all lumen packages), refer to www.designlights.org for details. ⁽⁷⁾Chicago rated version does not allow for row mounting. ⁽⁸⁾Two drivers required for 5LTHD option for 6400 lumens and up. ⁽⁹⁾347V option not available with 7400 lumen package. ⁽¹⁰⁾Air version is vented but does not meet air handling requirements; a 6% reduction in delivered lumens is experienced with this option. ⁽¹¹⁾Integral sensor works only with "CD" driver and is factory prewired to the driver for stand-alone control. ⁽¹²⁾Flex does not include dimming leads. Control leads provided by others. ⁽¹³⁾HCD driver option is not available with 7000 and 7400 lumen packages. Two drivers required for 6700 lumen package. ⁽¹⁴⁾Used to transfer fixture to secondary power source for life-safety operation. When used with a dimming fixture, two devices are required to ensure control is disabled while operating under emergency power. ⁽¹⁵⁾5LTD DALI option not available with 3000 and 3400 lumen packages.

Specifications & dimensions subject to change without notice. Consult your Eaton Representative for availability and ordering information.

ACCESSORIES

- T3A END E.Q. BRACKET PARTS BAG (Standard with fixture)
- DF-24-W=2' x 4' Drywall Frame Kit
- SK-24-WS=2' x 4' Shallow Surface Mount Kit
- SK-24-WT=2' x 4' Tall Surface Mount Kit
- DF10P-C_=Decorator Dimmer, 0-10V
- SF10P-_=Decorator Slide Dimmer, 0-10V
- ISHH-01=Programming Remote for Integrated Sensor
- ISHH-02=Personal Control Remote for Integrated Sensor

SHIPPING DATA

Catalog No.	Wt.
24EN-LD2-45	28 lbs.
24EN-LD2-54	28 lbs.
24EN-LD2-67	28 lbs.

INTEGRATED SENSOR

The Encounter with Integrated Sensor technology provides automatic energy savings without sacrificing performance. Traditionally, these types of energy savings required coordination between the luminaire and a lighting control system. The Encounter delivers superior lighting with integrated occupancy and daylighting controls.

Capture the benefits of traditional lighting controls, without complicated coverage planning or special wiring. Ideal for new construction or retrofit, the Encounter delivers automatic ON to an energy saving light level, while ensuring lighting is turned OFF when the space is unoccupied.

The integral daylight sensor reduces the need for special daylight zone planning. Each luminaire will automatically adjust the light level based on reflected light beneath the sensor in a closed loop method.

Occupied daylight light levels and unoccupied light levels can be adjusted using the integrated sensor programming remote (Catalog Number: ISHH-01). The integrated sensor personal remote (Catalog Number: ISHH-02) provides code compliant manual raise, lower, ON, OFF control.

The Encounter with Integrated Sensor is easy to install with no special wiring and ensures energy savings out-of-the-box with default control settings.

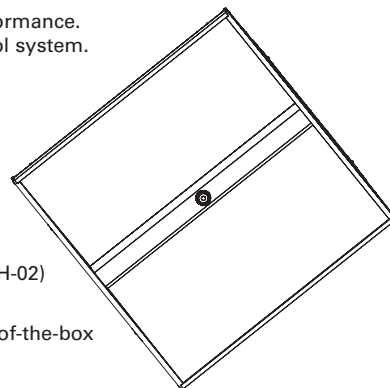

How it works:

- As the user enters the space controlled by the integral sensor, the lighting turns ON to the default daylight level.
- Lighting will remain at that the daylight level until the space is unoccupied. This will start the occupancy timeout period (default 20 minutes).
- If the space remains unoccupied for half of the timeout period, the lighting will automatically reduce to the Energy Saver light level. This adjustable light level is typically half of the occupied daylight level.
- At the end of the timeout period the lighting will go to the unoccupied light level. This adjustable light level uses the OFF default setting.

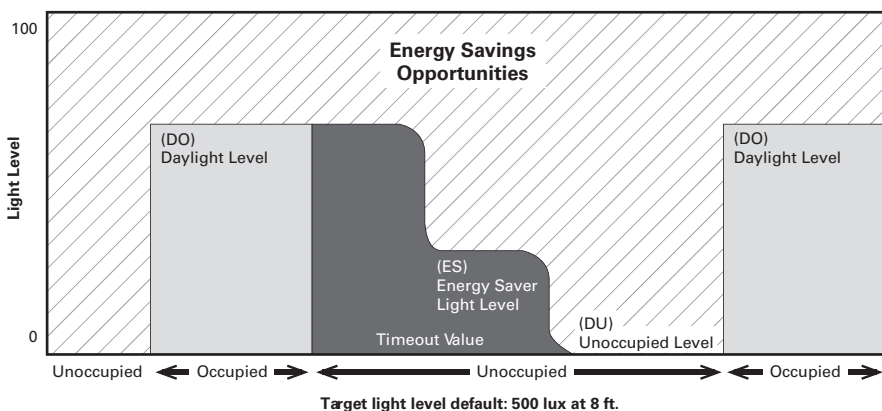

Coverage

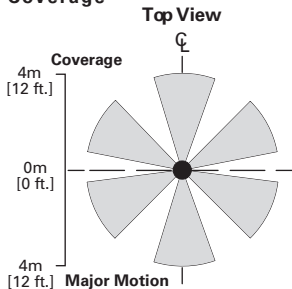

Side View

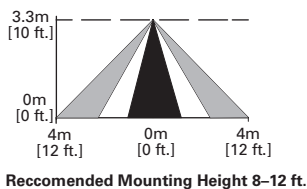

Optional Remote Controls



ISHH-01 Programming Remote



ISHH-02 Personal Control Remote