



Item#: **90995**
LED 8" RETROFIT CAN
 INDOOR FIXTURE

FEATURES

- Energy efficient: save up to 80% in energy costs
- High lumen output
- Instant-On
- For covered ceilings only
- Suitable for TYPE IC or NON-IC

APPLICATION

Ideal for retrofitting inefficient fixtures in malls, hospitals, airports, offices, lobbies and other commercial applications.

ELECTRICAL

Wattage	30W
Voltage	100-277V
Output Voltage	36V, 700mA
Current	0.241A
Power Factor	0.95
Total Harmonic Distortion (THD)	<25

LIGHTING PERFORMANCE

Lumens	2350
Lumens Per Watt (Lm/W)	78
Color Temperature (CCT)	5000K
Color Rendering (CRI)	83
R9 (Red Value)	3
R13 (Skin Tones)	85
Beam Angle	95°
Light Distribution	Type VS
Dimmable Lighting Control	<i>Dimmable</i> **see note on page 2

ENVIRONMENT

Operating Temperature	-40° ~ 104°F
Suitable Location	WET Indoor / Covered Ceilings
Ingress Protection Rating	IP43

LIFESPAN

Average Life (Hours)	50,000
Warranty (Years)	5

COMPONENTS

LED Light Source	Hongli 2835D
------------------	--------------

CONSTRUCTION

Housing	Aluminum Alloy
Base / Power Supply	Hard Wired
Finish	White

CERTIFICATIONS



Published lumens on LED products are approximate and may vary slightly. - Please check Energy Star website for the most current list of approved items - www.energystar.gov

Item#: **90995**
LED 8" RETROFIT CAN

DIMENSIONS (Inches)

Length	--
Width/Diameter	9.1"
Height	5.3"
Weight (Lbs)	--

Line drawings may not be to scale and are for general reference only.

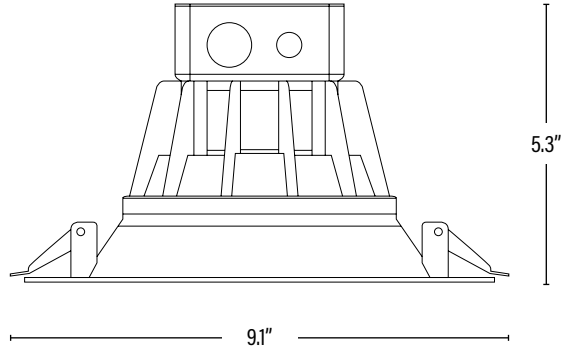

PACKAGING

		UPC	DIMENSIONS (LxWxH)	GROSS WEIGHT (Lbs)
Master Carton	6	10811768028611	--	--
Individual Box	1	811768028614	--	--
Country of Origin	China			
HS Tariff	9405.40.8200			

ORDERING

ITEM#	DESCRIPTION	CASE
90995	LED RETROFIT 8" CAN/WHITE/30W/50K/100-277V/DIMMABLE - SUPERIOR LIFE® ENERGY STAR®	6

ADDITIONAL INFORMATION:

Family Item: 90994/3000K

***90995 produced in 2016 thru 2017 are only dimmable at 120V, please reference compatibility chart.*

***90995 produced in 2018 and in the future are 0-10V dimming, no compatibility chart required.*

Production date code can be found on the etch.