



COLOR/WATTAGE SELECTABLE LED TROFFER FIXTURE

WARNING, CAUTION, SAFETY AND INSTALLATION INSTRUCTIONS

WARNING

- Installation, service, and maintenance of luminaires should be performed by a qualified licensed electrician.
- Specifications and dimensions subject to change without notice.
- Avoid direct eye exposure to the light source when it is on.
- Account for small parts and destroy packing material, as these may be hazardous to children.

CAUTION

- Do not make or alter any open holes in the wiring enclosure or electrical components during installation.
- Verify that supply voltage is correct by comparing it with the luminaire label.
- All wiring connections should be capped with UL approved wire connectors.
- The green ground screw is in the proper location. Do not relocate.
- Minimum 90° supply conductors.

NOTICE

- Suitable for dry or damp locations.
- Type IC.

Installation Instructions

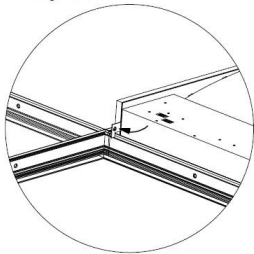
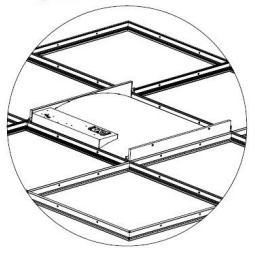
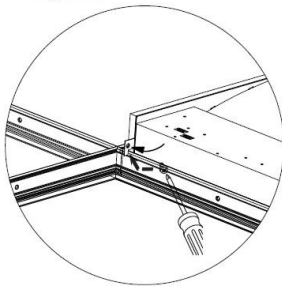
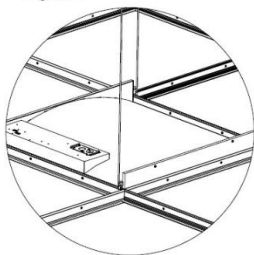
<p>1. Bend the mounting tab 90 degrees on each corner.</p> <p>Figure 1</p> 	<p>2. Lay the fixture into the T-grid.</p> <p>Figure 2</p> 
<p>3. Bend tabs flush against T-grid in order to accept the ceiling tile.</p> <p>Figure 3</p> 	<p>4. Use a #8x1/4" sheet metal screw to fasten the fixture to the T-grid and use a hanger wire (by others) to secure to ceiling in accordance with applicable codes.</p> <p>Figure 4</p> 



COLOR/WATTAGE SELECTABLE LED TROFFER FIXTURE

WARNING, CAUTION, SAFETY AND INSTALLATION INSTRUCTIONS

5. Ensure that the wiring of the last fixture in the row is properly terminated. Make all electrical connections to the fixture and reattach the wiring access cover plate.

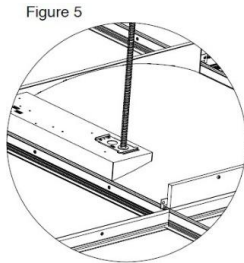

Wiring Diagram

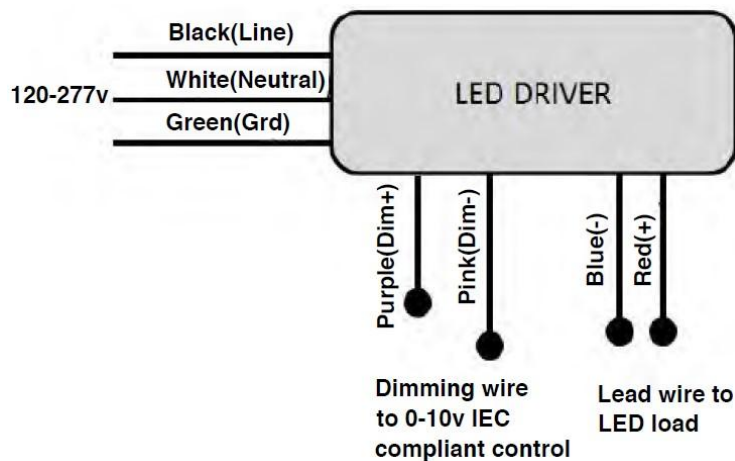

Field-Adjustable Wattage & CCT

The color temperature and lumen output can be adjusted from the two DIP switches located on the driver. Each DIP switch has 3 options (left, middle, and right), allowing 3500K (Natural White), 4000K (Cool White), and 5000K (Daylight) and 3 wattages (low, medium, or high).

Factory Settings:

- 2X2 – 40W, 5000K
- 2X4 - 50W, 5000K

1. DIP switches are on the driver box (see Figure 6).
2. Select a wattage and color temperature by sliding switch to the desired value (Figure 6A).

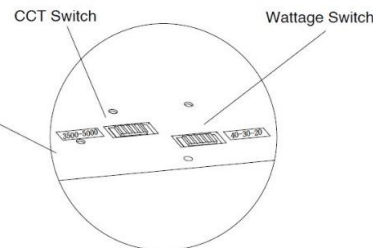
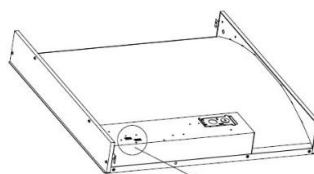



⚠ WARNING

- Before installing, servicing, or performing routine maintenance upon this equipment, follow these general precautions.
- To reduce the risk of death, personal injury, or property damage from fire, electric shock, falling parts, cuts/abrasions, and other hazards, read all warnings and instructions included with and on the fixture box and all fixture labels.
- Proper grounding is required to ensure safety.
- Power must be turned off at the breaker before installation or maintenance.
- This product must be installed in accordance with the applicable installation code by a person familiar with the construction and operation of the product and the hazards involved.
- Wear gloves and eye protection at all times while installing, servicing, or performing maintenance on the luminaire, and avoid direct eye exposure to the light source while it is on.
- To prevent wiring damage or abrasion, do not expose wiring to edges of sheet metal or other sharp objects.
- Do not install damaged product. Inspect luminaire for damage that may have occurred during transit. If damaged, contact the manufacturer immediately.
- These instructions do not purport to cover all details or variations in equipment nor to provide every possible contingency to meet in connection with installation, operation, or maintenance. Should further information be desired or should particular problems arise which are not covered sufficiently for the purchaser's or owner's purposes, contact the manufacturer.

⚠ ADVERTENCIA

- Antes de instalar, reparar o realizar el mantenimiento de rutina de este equipo, siga estas precauciones generales.
- Para reducir el riesgo de muerte, lesiones personales o daños a la propiedad por fuego, descarga eléctrica, caída de piezas, cortes / abrasiones y otros peligros, lea todas las advertencias y instrucciones incluidas con y en la caja del dispositivo y todas las etiquetas del dispositivo.
- Se requiere una conexión a tierra adecuada para garantizar la seguridad.
- Se debe apagar la energía en el disyuntor antes de la instalación o el mantenimiento.
- Este producto debe ser instalado de acuerdo con el código de instalación aplicable por una persona familiarizada con la construcción y operación del producto y los peligros involucrados.
- Utilice guantes y protección para los ojos en todo momento durante la instalación, el servicio o el mantenimiento de la luminaria, y evite la exposición directa de los ojos a la fuente de luz mientras está encendida.
- Para evitar daños o abrasiones en el cableado, no exponga el cableado a bordes de láminas de metal u otros objetos afilados.
- No instale un producto dañado. Inspeccione la luminaria en busca de daños que puedan haber ocurrido durante el tránsito. Si está dañado, comuníquese con el fabricante de inmediato.
- Estas instrucciones no pretenden cubrir todos los detalles o variaciones en el equipo ni proporcionar todas las posibles contingencias a cumplir en relación con la instalación, operación o mantenimiento. Si desea obtener más información o si surgen problemas particulares que no están suficientemente cubiertos para los propósitos del comprador o propietario, comuníquese con el fabricante.