



Sabre Wattage and Color Selectable LED Area Lights

DESCRIPTION

Outlasting and outperforming traditional metal halide fixtures, these beam angle, wattage, and color selectable LED area lights are ideal for a variety of outdoor applications.

FEATURES

- Up to 160 LPW ultra-high efficiency delivers superior performance over older HID fixtures
- Output varies depending on the wattage and color temperature selected, see Selectable Table for full breakdown
- Switchable lenses allow you to swap between Type III (pre-installed), Type IV, and Type V light distribution
- Type III light distribution projects light outwards with a lateral width of 40 degrees
- Type IV light distribution projects light outwards in a wide forward throw with very little light spillage behind the fixture, making it ideal for perimeter lighting
- Type V light distribution projects light in a circular pattern with the same intensity at all angles
- 0-10V dimming
- 3.9' whip
- Mounting accessories sold separately, see Accessories section for full list of compatible mounts
- Shielding accessories sold separately, see Accessories sections for full list of compatible mounts
- Wattage and color temperature can be adjusted using the switched location on the driver of the fixture; see installation instructions for more information

LISTINGS

- UL Listed for wet locations
- IP65
- IK08
- DesignLights Consortium® 5.1 Premium - meets the requirements for the highest DLC qualification for efficacy and lumen maintenance

PERFORMANCE

- CRI: >80
- CCT: 3000K, 4000K, & 5000K
- LED L70 Life Hours:
 - 145,000 hours - PLT-13145
 - 155,000 hours - PLT-13144
- Light Distribution: Type III/Type V or Type III/Type IV/Type V
- SMD 2835 LEDs & Sosen driver

THERMAL

- -40°F to 122°F (-40°C to 50°C) operating temperature

ELECTRICAL

- THD: ≤20%
- Power Factor: ≥0.9
- Input Voltage: 120-277V, 277-480V
- Dimmable power supply (0-10V)
- Surge Protection: 6kV, 10kV

Project name	Type
Catalog number	
Comments	Voltage
Approved by	Date



INSTALLATION

- Designed to be mounted with Sabre Series slipfitters, straight arms, or U brackets (all sold separately), see Mounting Accessories section for full list of compatible products. See installation instructions for more information on how to install these fixtures.

CONSTRUCTION

- Low profile die-cast aluminum housing
- Durable dark bronze powder coat finish
- Polycarbonate lens

WARRANTY

- 5-year limited warranty; see pltsolutions.com for warranty details

APPLICATIONS

- Parking Lots
- Automotive Dealerships
- Roadways
- Campuses
- Area Security Lighting
- Airports

PERFORMANCE SUMMARY

Item #	Family	Watts*	CCT*	CRI	Dimming	Voltage	Replaces	Light Distribution	BUG	DLC #	DLC Level
PLT-13144	Sabre Series	100/ 120/ 150	3000K/ 4000K/ 5000K	>80	0-10V	120-277V	MH400	Type III & Type V	B4-U0-G4	PLTSNIB112[1;2;3]3[1;2;blank] [1;2;3;4;5;6;blank][1;2;3;4;5;6]	5.1 Premium
PLT-13145	Sabre Series	200/ 240/ 300	3000K/ 4000K/ 5000K	>80	0-10V	120-277V	MH1000	Type III & Type V	B5-U0-G5	PLTSNIB212[1;2;3]3[1;2;blank] [1;2;3;4;5;6;blank][1;2;3;4;5;6]	5.1 Premium

* See Selectable Table for full breakdown

SELECTABLE TABLE

SKU	Wattage	Voltage	CCT	Lumens	Efficacy
PLT-13144	100	AC120V	3000K	14,707	147
			4000K	15,193	152
			5000K	15,276	153
	120		3000K	16,833	140
			4000K	17,666	147
			5000K	17,617	147
	150		3000K	21,782	145
			4000K	21,507	143
			5000K	22,238	148
PLT-13145	200	AC120V	3000K	30,734	154
			4000K	31,924	160
			5000K	31,972	160
	240		3000K	35,616	148
			4000K	37,228	155
			5000K	37,099	155
	300		3000K	43,363	145
			4000K	45,922	153
			5000K	45,605	152

ACCESSORIES (SOLD SEPARATELY)



PLT-13146

FOR 2 1/2 IN. TENON
ADJUSTABLE 0-90°
COMPATIBLE WITH:
PLT-13144, PLT-13145,
PLT-13750, PLT-13751



PLT-13147

FOR SQUARE POLES
ADJUSTABLE 0-35°
COMPATIBLE WITH:
PLT-13144, PLT-13145,
PLT-13750, PLT-13751



PLT-13148

FOR SELECT 150W
SABRE AREA LIGHTS
ADJUSTABLE 0-180°
COMPATIBLE WITH:
PLT-13144



PLT-13149

FOR SELECT 300W
SABRE AREA LIGHTS
ADJUSTABLE 0-180°
COMPATIBLE WITH:
PLT-13144

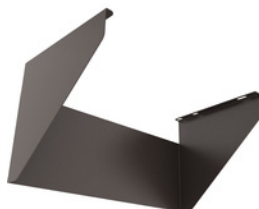

PLT-13153

FRONT CUTOFF SHIELD
COMPATIBLE WITH:
PLT-13144

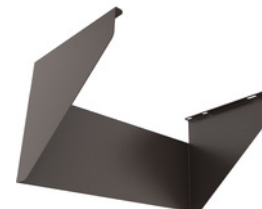

PLT-13154

BACK CUTOFF SHIELD
COMPATIBLE WITH:
PLT-13144



PLT-13155

LEFT CUTOFF SHIELD
COMPATIBLE WITH:
PLT-13144



PLT-13156

RIGHT CUTOFF SHIELD
COMPATIBLE WITH:
PLT-13144

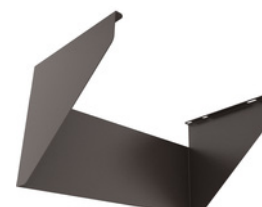

PLT-13157

FRONT CUTOFF SHIELD
COMPATIBLE WITH:
PLT-13145

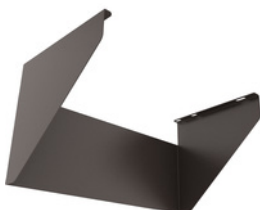

PLT-13158

BACK CUTOFF SHIELD
COMPATIBLE WITH:
PLT-13145



PLT-13159

LEFT CUTOFF SHIELD
COMPATIBLE WITH:
PLT-13145



PLT-13160

RIGHT CUTOFF SHIELD
COMPATIBLE WITH:
PLT-13145

FIXTURES DIMENSIONS

PLT-13144

Length: 19.5"
 Height: 3.1"
 Width: 10.6"
 Weight: 9.01 lbs



PLT-13145

Length: 21.5"
 Height: 3.1"
 Width: 12.7"
 Weight: 11.22 lbs



MOUNTS DIMENSIONS

PLT-13146:

Length - 6.95"
 Height - 4.88"
 Width - 2.84"
 Diameter - 2.44"
 Weight - 1.44 lbs

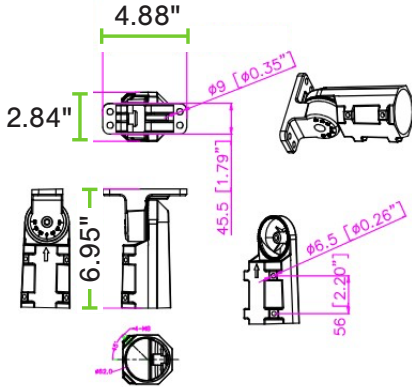

PLT-13147:

Length - 9"
 Height - 6.28"
 Width - 4.88"
 Weight - 2.21 lbs

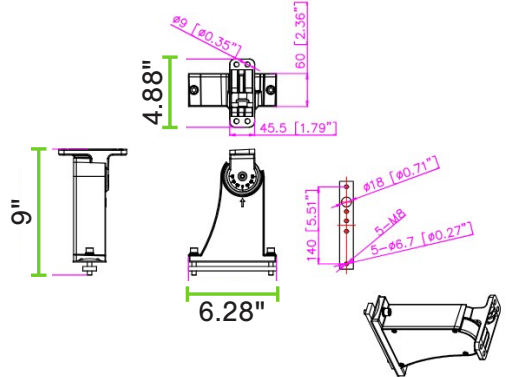

PLT-13148:

Length - 11.82"
 Height - 2.05"
 Width - 8.55"
 Weight - 1.35 lbs

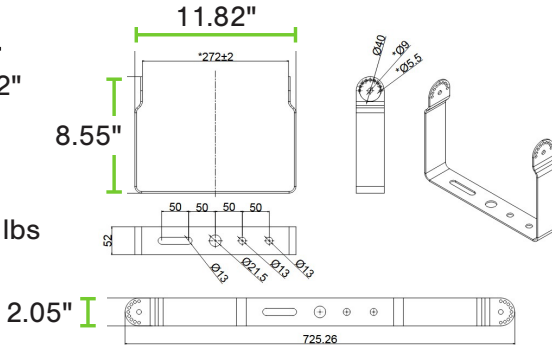

PLT-13149:

Length - 13.86"
 Height - 2.05"
 Width - 8.55"
 Weight - 1.99 lbs

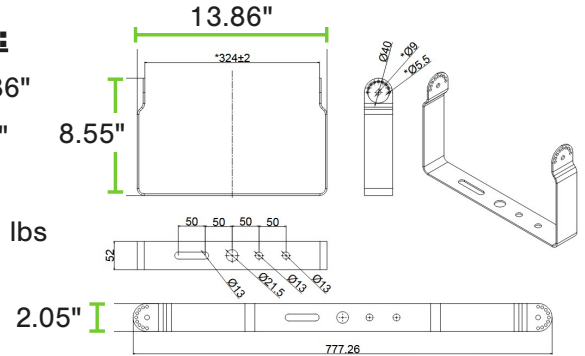

SHIELDS DIMENSIONS

PLT-13153:

Length - 10.75"
 Width - 5.51"
 Height - 2.95"
 Weight - 1.25 lbs

PLT-13154:

Length - 10.75"
 Width - 5.51"
 Height - 2.95"
 Weight - 1.25 lbs

PLT-13155:

Length - 10.24"
 Width - 5.56"
 Height - 0.48"
 Weight - 1.02 lbs

PLT-13156:

Length - 10.24"
 Width - 5.56"
 Height - 0.48"
 Weight - 1.02 lbs

PLT-13157:

Length - 12.80"
 Width - 6.74"
 Height - 6.78"
 Weight - 1.27 lbs

PLT-13158:

Length - 12.80"
 Width - 6.74"
 Height - 6.78"
 Weight - 1.27 lbs

PLT-13159:

Length - 12.21"
 Width - 6.78"
 Height - 0.48"
 Weight - 1.3 lbs

PLT-13160:

Length - 12.21"
 Width - 6.78"
 Height - 0.48"
 Weight - 1.3 lbs

PLT-13144 – TYPE III

100W, 3000K, 120V

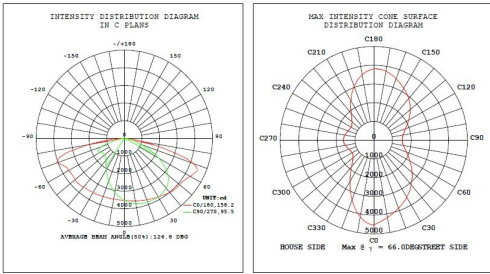

100W, 4000K, 120V

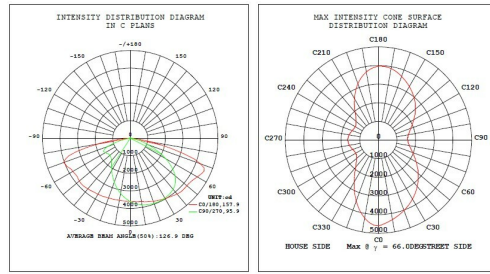

100W, 5000K, 120V

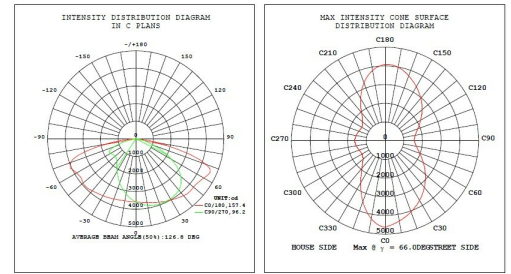

120W, 3000K, 120V

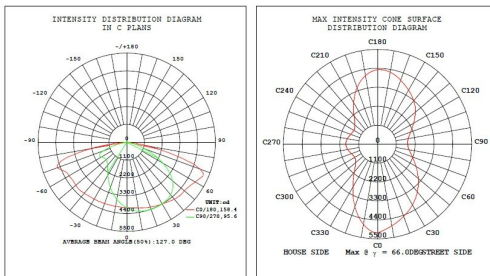

120W, 4000K, 120V

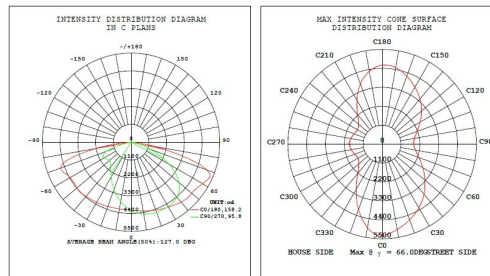

120W, 5000K, 120V

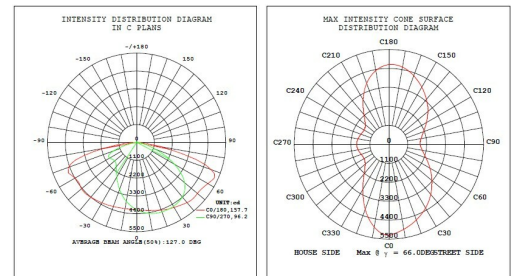

150W, 3000K, 120V

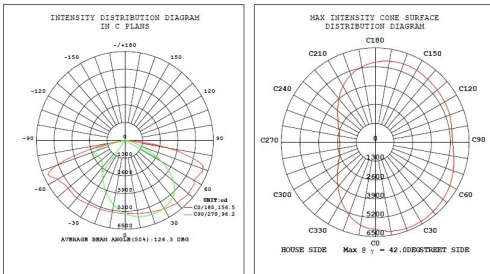

150W, 4000K, 120V

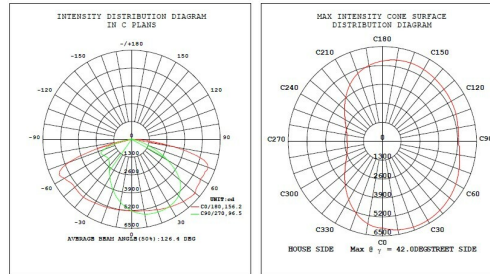

150W, 5000K, 120V

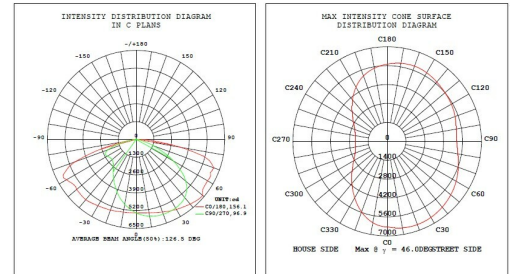

PLT-13144 – TYPE V

150W, 3000K, 120V

Luminous Intensity Distribution Curve

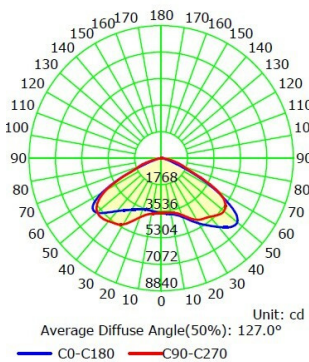

PLT-13145 – TYPE III

200W, 3000K, 120V

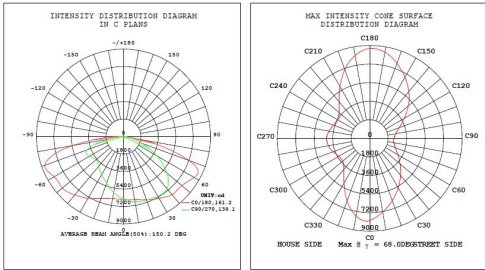

200W, 4000K, 120V

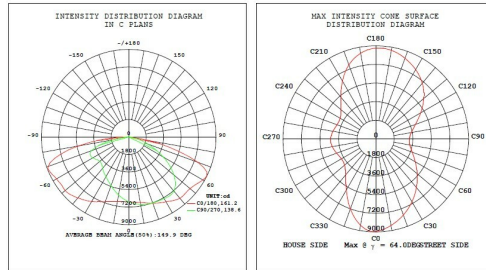

200W, 5000K, 120V

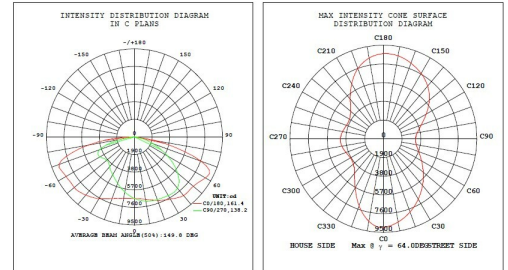

240W, 3000K, 120V

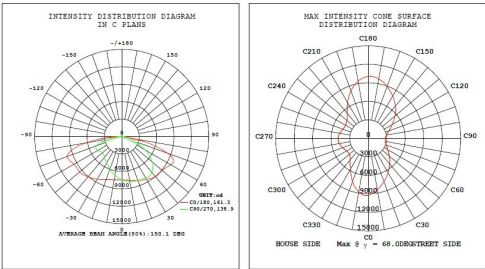

240W, 4000K, 120V

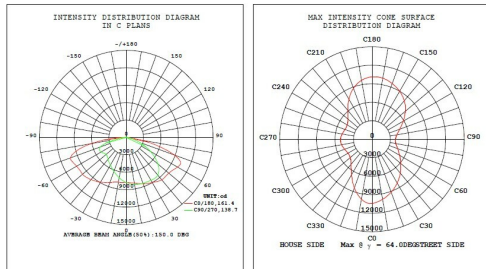

240W, 5000K, 120V

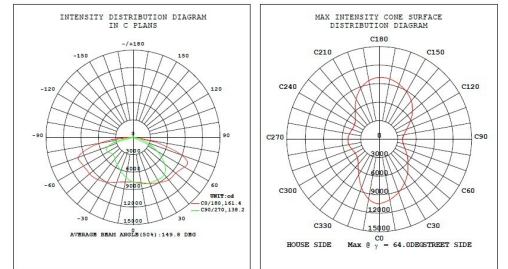

300W, 3000K, 120V

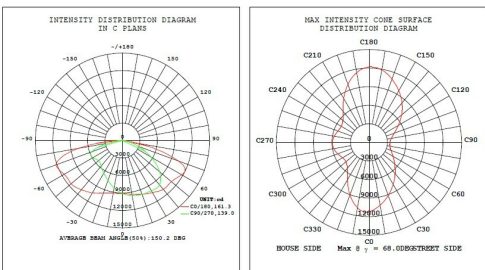

300W, 4000K, 120V

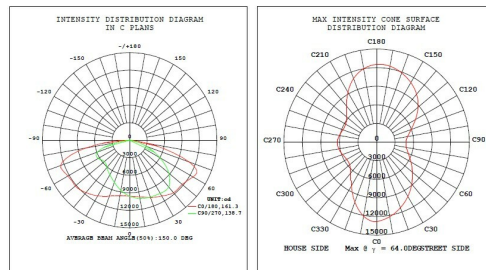

300W, 5000K, 120V

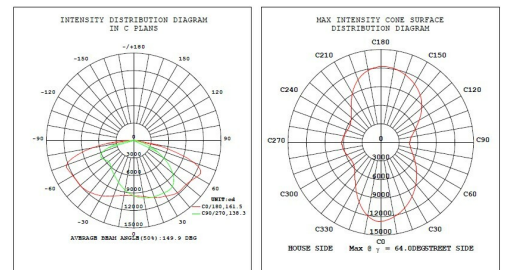

PLT-13145 – TYPE V

300W, 3000K, 120V

Luminous Intensity Distribution Curve

