



# COLOR/WATTAGE SELECTABLE LED STRIP FIXTURE W/ EMERGENCY BATTERY BACKUP

## WARNING, CAUTION, SAFETY AND INSTALLATION INSTRUCTIONS

### WARNING

- Installation, service, and maintenance of luminaires should be performed by a qualified licensed electrician.
- Specifications and dimensions subject to change without notice.
- Account for small parts and destroy packing material, as these may be hazardous to children.
- Risk of burn. Disconnect the power and allow the fixture to cool before handling.
- Turn off electrical power at fuse or circuit breaker box before installation or maintenance.

### CAUTION

- Do not create or alter any holes in the wiring enclosure or in any of the electrical components.
- Verify that supply voltage is correct by comparing it with the luminaire label.
- Equipment should be mounted in locations and at heights where it is not subject to tampering by unauthorized personnel.
- The use of accessory equipment is not recommended by the manufacturer and may cause an unsafe condition.
- Do not use this equipment for any other purpose than its intended use.
- This LED emergency backup unit requires an un-switched AC power source of 100-347Vac, 50/60Hz. The AC driver must be on the same branch circuit as the LED emergency backup unit.
- All wiring connections should be capped with UL approved wire connectors.
- Green ground screw is located in the proper position. Do not relocate.
- Minimum 90°C supply conductors.

### NOTICE

- Do not use outdoors.
- Do not mount near gas or electric heaters.

### Installation Instructions

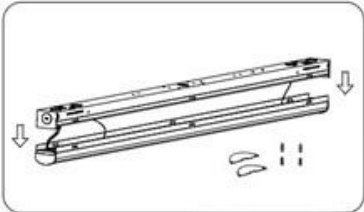

#### Surface Mounting

1. Take the light fixture out of the box.	
2. Separate the module board from the fixture base to retrieve the mounting hardware.	

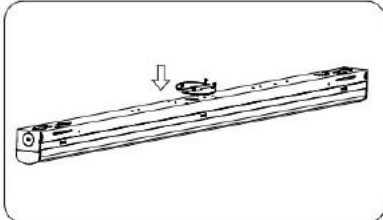
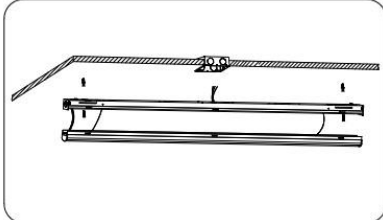
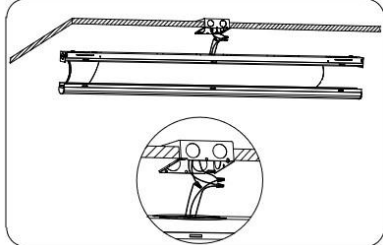

# COLOR/WATTAGE SELECTABLE LED STRIP FIXTURE W/ EMERGENCY BATTERY BACKUP

## WARNING, CAUTION, SAFETY AND INSTALLATION INSTRUCTIONS

3. Attach the junction box covers to the fixture.	
4. Secure the fixture to the ceiling with the provided plastic sleeve and screws.	
5. Wire to the main supply power through the junction box (see Wiring Diagram).	
6. Reattach the module board to the fixture base to finish the installation.	

## Wiring Diagram

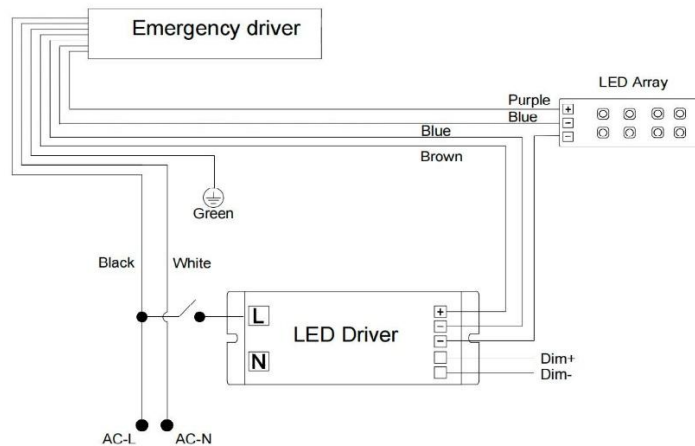



**COLOR/WATTAGE SELECTABLE LED STRIP FIXTURE W/ EMERGENCY BATTERY BACKUP**  
**WARNING, CAUTION, SAFETY AND INSTALLATION INSTRUCTIONS**

**Emergency Operation**

**AC Operation**

- When AC power is present, the fixture operates normally, and the emergency driver remains in standby. The AC LED driver output cannot exceed 150W or 4A. A flashing green LED indicates charging, and a solid green light shows it is fully charged

**Emergency Operation**

- The emergency driver will detect a power outage, and will automatically switch to emergency mode.

**Self-Testing**

- The emergency driver is UL listed and equipped with self-testing functionality.

**Initial Self-Test After Installation**

- The emergency driver will perform a 3 second functional test after installation. Then, it will perform a second test 120 minutes after the first to verify wiring and battery output. The LED indicator light will be OFF or flicker if a failure or error has occurred.

**Monthly Self-Test**

- The emergency driver will automatically perform a 3 second self-test every 30 days, diagnosing wiring and battery output. If the LED indicator light is blinking or OFF, a failure has occurred.

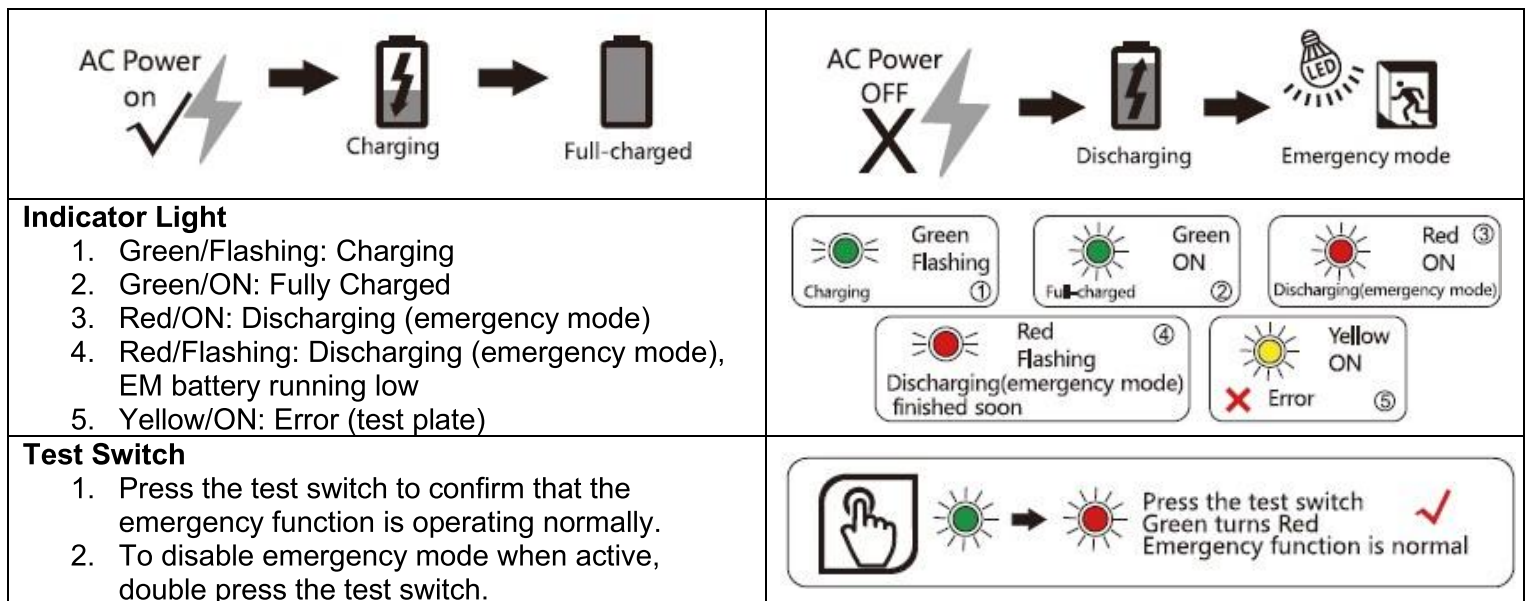



## COLOR/WATTAGE SELECTABLE LED STRIP FIXTURE W/ EMERGENCY BATTERY BACKUP

WARNING, CAUTION, SAFETY AND INSTALLATION INSTRUCTIONS

### Field-Adjustable Wattage & CCT

Users may adjust the color temperature and lumen output using the two DIP Switches located on the driver. Each DIP switch provides 3 options (left, middle, and right) allowing one of three color temperatures and three wattages.

#### Factory Settings:

- Highest wattage option and highest CCT option.
1. DIP switches are located on the driver box.
  2. Select the wattage and color temperature by sliding the switch left or right to the desired value.

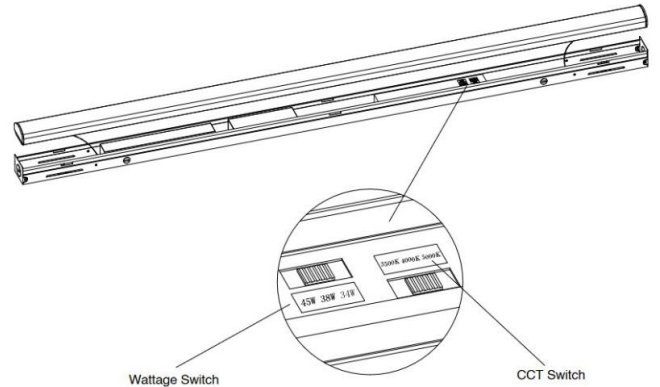

### ⚠ WARNING

- Before installing, servicing, or performing routine maintenance upon this equipment, follow these general precautions.
- To reduce the risk of death, personal injury, or property damage from fire, electric shock, falling parts, cuts/abrasions, and other hazards, read all warnings and instructions included with and on the fixture box and all fixture labels.
- Proper grounding is required to ensure safety.
- Power must be turned off at the breaker before installation or maintenance.
- This product must be installed in accordance with the applicable installation code by a person familiar with the construction and operation of the product and the hazards involved.
- Wear gloves and eye protection at all times while installing, servicing, or performing maintenance on the luminaire, and avoid direct eye contact to the light source while it is on.
- To prevent wiring damage or abrasion, do not expose wiring to edges of sheet metal or other sharp objects.
- Do not install damaged product. Inspect luminaire for damage that may have occurred during transit. If damaged, contact the manufacturer immediately.
- These instructions do not purport to cover all details or variations in equipment nor to provide every possible contingency to meet in connection with installation, operation, or maintenance. Should further information be desired or should particular problems arise which are not covered sufficiently for the purchaser's or owner's purposes, contact the manufacturer.

### ⚠ ADVERTENCIA

- Antes de instalar, reparar o realizar el mantenimiento de rutina de este equipo, siga estas precauciones generales.
- Para reducir el riesgo de muerte, lesiones personales o daños a la propiedad por fuego, descarga eléctrica, caída de piezas, cortes / abrasiones y otros peligros, lea todas las advertencias y instrucciones incluidas con y en la caja del dispositivo y todas las etiquetas del dispositivo.
- Se requiere una conexión a tierra adecuada para garantizar la seguridad.



## COLOR/WATTAGE SELECTABLE LED STRIP FIXTURE W/ EMERGENCY BATTERY BACKUP

### WARNING, CAUTION, SAFETY AND INSTALLATION INSTRUCTIONS

- Se debe apagar la energía en el disyuntor antes de la instalación o el mantenimiento.
- Este producto debe ser instalado de acuerdo con el código de instalación aplicable por una persona familiarizada con la construcción y operación del producto y los peligros involucrados.
- Utilice guantes y protección para los ojos en todo momento durante la instalación, el servicio o el mantenimiento de la luminaria, y evite la exposición directa de los ojos a la fuente de luz mientras está encendida.
- Para evitar daños o abrasiones en el cableado, no exponga el cableado a bordes de láminas de metal u otros objetos afilados.
- No instale un producto dañado. Inspeccione la luminaria en busca de daños que puedan haber ocurrido durante el tránsito. Si está dañado, comuníquese con el fabricante de inmediato.
- Estas instrucciones no pretenden cubrir todos los detalles o variaciones en el equipo ni proporcionar todas las posibles contingencias a cumplir en relación con la instalación, operación o mantenimiento. Si desea obtener más información o si surgen problemas particulares que no están suficientemente cubiertos para los propósitos del comprador o propietario, comuníquese con el fabricante.