



## 1X1 SURFACE MOUNT LED PANELS

### WARNING, CAUTION, SAFETY AND INSTALLATION INSTRUCTIONS

#### WARNING

- Installation, service, and maintenance of luminaires should be performed by a qualified licensed electrician.
- Read all installation instructions before installing this product.
- Specifications are subject to change without notice.
- Unpack and carefully examine the luminaire. If any pieces are missing or damaged, contact the manufacturer immediately.

#### CAUTION

- Consult a qualified electrician to ensure the correct branch circuit conductor.
- This luminaire is set to work at extra low voltage below DC42V and constant current conditions to ensure safety.
- Designed for use in 100V~277V, 50-60Hz protect circuit. Apply Class 2 power supply.

#### NOTICE

- Suitable for suspended ceilings. Access to the area above the ceiling is required.
- Suitable for damp locations.

### Installation Instructions

#### Recessed Installation

- Step 1. Remove appropriate round knock-out(s) and connect conduit to J-box with proper connector(s).
- Step 2. Attach a connector to the end of the AC input wire. Connect the L wire to the black wire, the N wire to the white wire, and the ground to the green wire (Figure 1).
- Step 3. Push all wire back into the junction box and close (Figure 2).

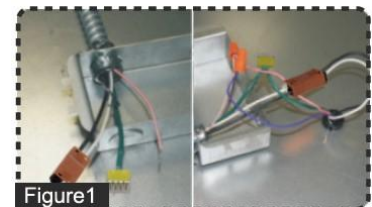

#### Surface Mount to J-Box

This fixture is compatible with the junction boxes listed below (Figure 1):

- 3.5" Octagon
- 4" Octagon
- 4" Round
- 6" Square

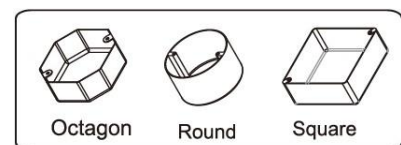
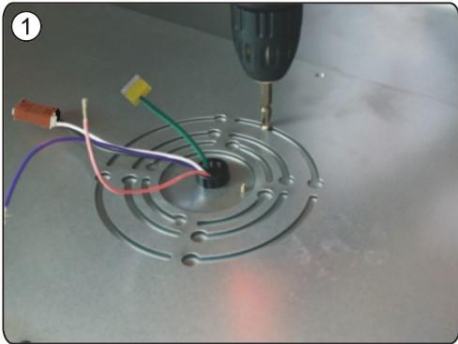
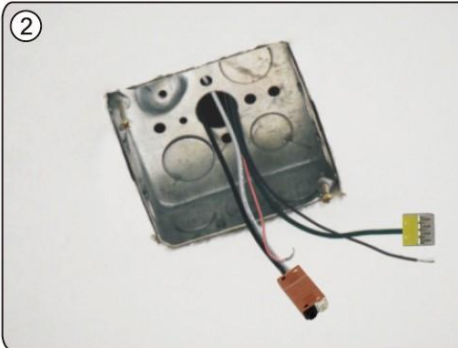
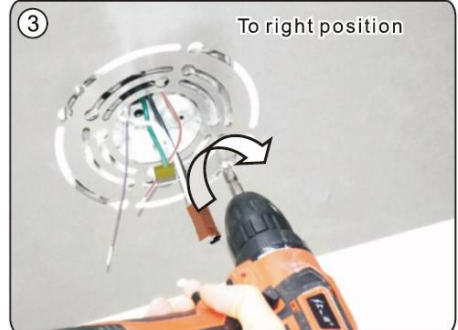
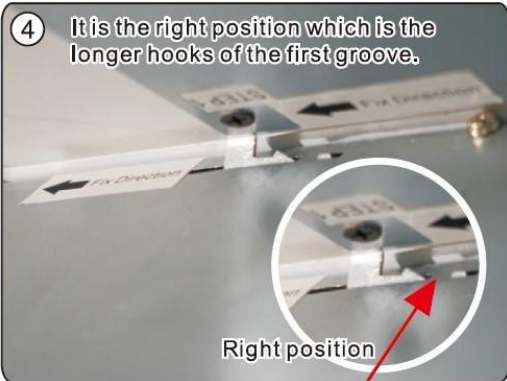

Figure 1



## 1X1 SURFACE MOUNT LED PANELS

### WARNING, CAUTION, SAFETY AND INSTALLATION INSTRUCTIONS

<p>Step 1. Remove the surface mounted kit from the luminaire.</p>	 <p>1</p>
<p>Step 2. Turn off the power. Insert the L and N wires of the J-box into the male connector.</p>	 <p>2</p>
<p>Step 3. Align the holes from the surface mount plate to the holes on the J-box and pull the wiring through, then insert 2 #8-32 screws to attach the plate to the J-box.</p> <p>Turn the plate to the right, then tighten the screws in place. Lock the plate in position by inserting KA3.5*20 screws into the ceiling through the plate slits until it is flush to the ceiling.</p>	 <p>3 To right position</p>
<p>Step 4. Lock the hooks from the mounting plate to the hook slots on the luminaire (see stickers on the plate and luminaire).</p>	 <p>4 It is the right position which is the longer hooks of the first groove.</p> <p>Right position</p>



## 1X1 SURFACE MOUNT LED PANELS

### WARNING, CAUTION, SAFETY AND INSTALLATION INSTRUCTIONS

Step 5. Attach the safety cable on the available hook.

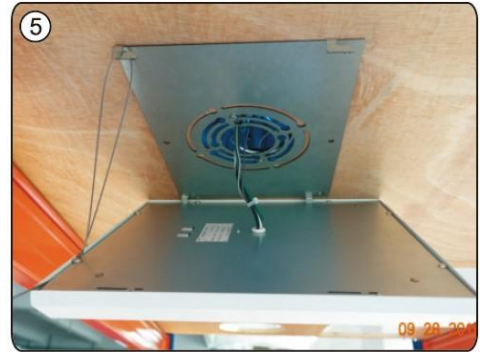

Step 6. Plug the female connector from the luminaire to the male connector of the AC input wires. Use 4-way terminals to connect the ground to green wire.

If using 0-10V dimming, use wire nuts to connect the dimming wire according to wire colors. If not dimming the fixture, cap the unused wires with wire nuts.

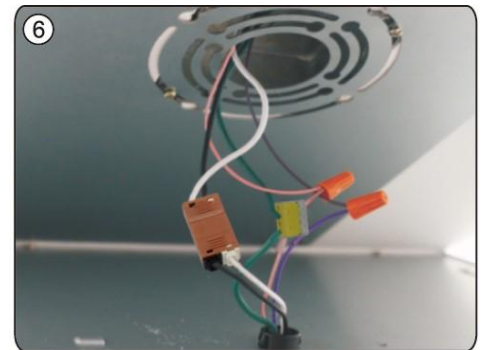

Step 7. After completing all connections, push all wiring into the J-box.

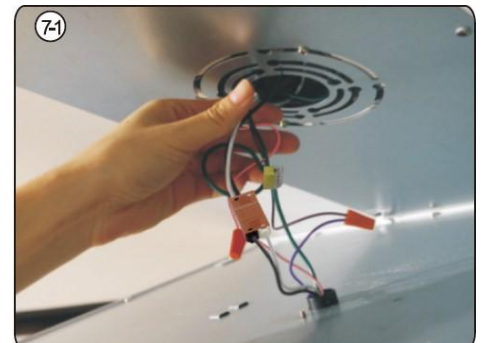



## 1X1 SURFACE MOUNT LED PANELS

### WARNING, CAUTION, SAFETY AND INSTALLATION INSTRUCTIONS

Step 8. Push the unhooked side of the luminaire up into the plate hooks, then slide forward until you hear the hooks lock into the hook slots.



## Wiring Diagram

### For 0-10V Dimming

1. Compatible with 0-10V dimmers
2. Connect the driver PUR (D+) to the dimmer+ (PUR), and the driver PINK (D-) to the dimmer- (PINK).
3. Connect the wires with terminal cap as shown in the wiring diagram.
4. Incoming insulated dimming conductors shall have voltage rated at least equal to the branch voltage.

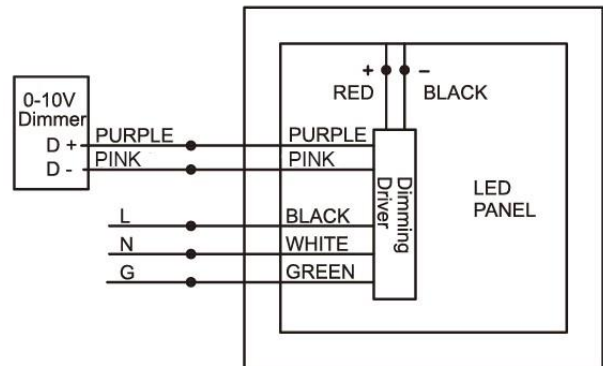

## ⚠ WARNING

- Before installing, servicing, or performing routine maintenance upon this equipment, follow these general precautions.
- To reduce the risk of death, personal injury, or property damage from fire, electric shock, falling parts, cuts/abrasions, and other hazards, read all warnings and instructions included with and on the fixture box and all fixture labels.
- Proper grounding is required to ensure safety.
- Power must be turned off at the breaker before installation or maintenance.
- This product must be installed in accordance with the applicable installation code by a person familiar with the construction and operation of the product and the hazards involved.



## 1X1 SURFACE MOUNT LED PANELS

### WARNING, CAUTION, SAFETY AND INSTALLATION INSTRUCTIONS

- Wear gloves and eye protection at all times while installing, servicing, or performing maintenance on the luminaire, and avoid direct eye exposure to the light source while it is on.
- To prevent wiring damage or abrasion, do not expose wiring to edges of sheet metal or other sharp objects.
- Do not install damaged product. Inspect luminaire for damage that may have occurred during transit. If damaged, contact the manufacturer immediately.
- These instructions do not purport to cover all details or variations in equipment nor to provide every possible contingency to meet in connection with installation, operation, or maintenance. Should further information be desired or should particular problems arise which are not covered sufficiently for the purchaser's or owner's purposes, contact the manufacturer.

### **⚠ ADVERTENCIA**

- Antes de instalar, reparar o realizar el mantenimiento de rutina de este equipo, siga estas precauciones generales.
- Para reducir el riesgo de muerte, lesiones personales o daños a la propiedad por fuego, descarga eléctrica, caída de piezas, cortes / abrasiones y otros peligros, lea todas las advertencias y instrucciones incluidas con y en la caja del dispositivo y todas las etiquetas del dispositivo.
- Se requiere una conexión a tierra adecuada para garantizar la seguridad.
- Se debe apagar la energía en el disyuntor antes de la instalación o el mantenimiento.
- Este producto debe ser instalado de acuerdo con el código de instalación aplicable por una persona familiarizada con la construcción y operación del producto y los peligros involucrados.
- Utilice guantes y protección para los ojos en todo momento durante la instalación, el servicio o el mantenimiento de la luminaria, y evite la exposición directa de los ojos a la fuente de luz mientras está encendida.
- Para evitar daños o abrasiones en el cableado, no exponga el cableado a bordes de láminas de metal u otros objetos afilados.
- No instale un producto dañado. Inspeccione la luminaria en busca de daños que puedan haber ocurrido durante el tránsito. Si está dañado, comuníquese con el fabricante de inmediato.
- Estas instrucciones no pretenden cubrir todos los detalles o variaciones en el equipo ni proporcionar todas las posibles contingencias a cumplir en relación con la instalación, operación o mantenimiento. Si desea obtener más información o si surgen problemas particulares que no están suficientemente cubiertos para los propósitos del comprador o propietario, comuníquese con el fabricante.